

GAS FIREBRICK® INSERTS FOR FIREPLACES



QUADRA-FIRE

PURE PERFORMANCE



UPGRADES IN PERFORMANCE AND STYLE

Quadra-Fire® FireBrick® gas inserts fit directly into existing fireplaces and immediately provide upgrades in performance, durability and style.

These gas inserts use FireBrick technology—a patented firebox material which adds authentic brick detail and captures radiant heat to increase output as much as 25 percent. Control the powerful heating with wall or remote thermostats.

Take back your fireplace and feel the warmth. It's all possible with the proven performance of Quadra-Fire FireBrick gas inserts.

COVER: QFI35FB shown with tuscan bar front in black with antique pewter accents.

ABOVE: QFI30FB shown with firescreen leaves front in black.

GAS FIREBRICK INSERTS

QFI35FB

The QFI35FB is made to fill larger existing fireplaces. Its classic styling is accented with bold flames rising through a detailed log set and illuminated embers. The IntelliFire™ Plus ignition system, powerful heat output and advanced technology deliver comfort and convenience.

QFI35FB shown with firescreen front in black.



QFI30FB

The QFI30FB is ideal for transforming smaller existing fireplaces into efficient, attractive sources of warmth. A standard full-function remote control allows the fan speed, flame intensity and heat output to be quickly adjusted. Make the QFI30FB your own with numerous unique finishing options.

QFI30FB shown with Firescreen Leaves in Black.



FIREBRICK TECHNOLOGY

FireBrick is a patented, energy-saving ceramic material molded into an authentic masonry design. FireBrick produces up to 25% more radiant heat than metal fireboxes—heating rooms faster and using less fuel. This increases efficiency and reduces heating costs.

To learn more about FireBrick Technology visit quadrafire.com.





A NEW FIREPLACE INSERT IN FOUR EASY STEPS

- 1) Measure your existing fireplace
- 2) Select your insert
- 3) Choose your surround
- 4) Customize your insert

QFI35FB shown with firescreen front in black.

GAS FIREBRICK INSERTS

STEP 1 MEASURE YOUR EXISTING FIREPLACE

The height, width and depth of the existing fireplace opening is needed to ensure an appropriately-sized insert is selected.

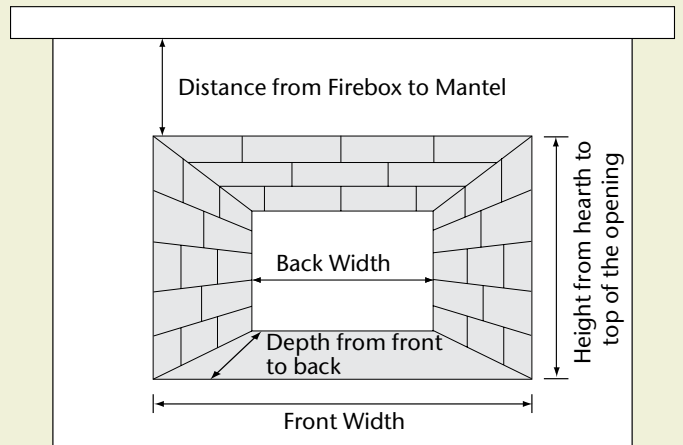

STEP 2 SELECT YOUR INSERT

Selecting an insert consists of two main factors. Keep these in mind and you're sure to make a solid choice

- Consider the size of your existing fireplace opening. Try and fill that space.
- Consider how your insert will be used. Room size, heating needs and usage frequency all come into play.



QFI35FB

- 35" viewing area
- Up to 40,000 BTUs
- 7 oak-style logs
- Illuminated ember bed and accent lighting
- Standard 120 CFM blower



QFI30FB

- 30" viewing area
- Up to 36,000 BTUs
- 7 oak-style logs
- Illuminated ember bed and accent lighting
- Standard 120 CFM blower

STEP 3 CHOOSE YOUR SURROUND

Surrounds remove the gap between the fireplace insert and existing fireplace opening. Choose from numerous sizes and styles for a unique look.

Three surround sizes are available, in Black or Sienna Bronze.

SURROUND	QFI35FB	QFI30FB
Small	42" x 29"	40" x 27"
Medium	44" x 32"	42" x 30"
Large	48" x 32"	44" x 32"

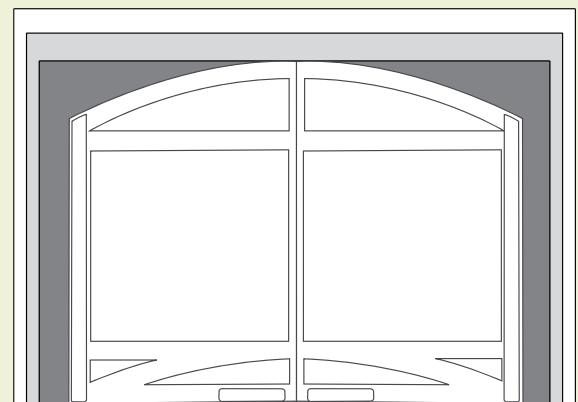

■ STANDARD SURROUND ■ MEDIUM SURROUND ■ LARGE SURROUND

GAS FIREBRICK INSERTS

STEP 4 CUSTOMIZE YOUR INSERT

Make it your own. Select a front and termination cap to complete your look.

FRONTS



Tuscan Bar - Available in Black with Antique Pewter accents or Sienna Bronze with Antique Copper accents



Tudor Panel - Available in Black or Sienna Bronze



Firescreen - Available in Black or Sienna Bronze



Firescreen Leaves - Available in Black or Sienna Bronze

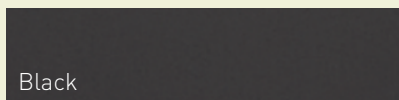

Black

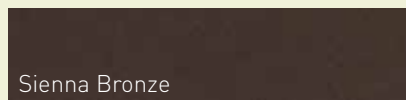

Sienna Bronze

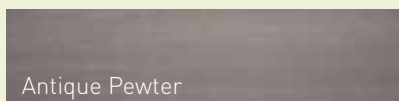

Antique Pewter

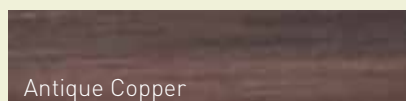

Antique Copper

TERMINATION CAPS

A termination cap finishes your gas insert with a clean, upscale look. And, these durable caps also protect venting components and ensure safe exhaust flow.



Round Termination Cap



Square Termination Cap - Available in black or copper finish

EMBER LIGHTING

Illuminated ember bed adds ambiance and detail to powerful fires—and allow you to enjoy a glowing ambiance with or without flames.



DIRECT VENT TECHNOLOGY

Direct Vent fireplaces remove 100% of combustion exhaust and odors outside of the home. These sealed fireplaces provide optimal heat, conserve energy and ensure clean, safe indoor air quality. To learn more visit quadrafire.com.

INTELLIFIRE™ PLUS IGNITION SYSTEM

The IntelliFire™ Plus Ignition System (IPI Plus) is an advanced intermittent pilot ignition system with memory settings and a programmable wireless control. IPI Plus constantly monitors ignition, ensures safe functioning and conserves up to \$10/month in energy costs. To learn more visit quadrafire.com.

INTELLIFIRE PLUS RC300 This remote control is designed to wirelessly control the QFI35FB or QFI30FB. A large LCD screen and simple navigation provide easy operation. The RC300 can also be docked on the wall to mimic a thermostat, or used as a remote.

MODEL: RC300-QDF

FEATURES: Auto Battery Backup, Pilot Activation, On/Off, 5 Step Flame Height, Fan Speed (Auxiliary 1), Two Additional Auxiliary Functions, Room Temperature Readout, Thermostat Mode, Timer Mode, Child Lock, Wall Docking Station



	GAS FIREBRICK INSERT SPECIFICATIONS							
	Technical Data					Performance		
	Shipping Weight	Flue Size	Ignition System	Mobile Home Approved	Bedroom Approved	Btu/Hr Input (NG)	Btu/Hr Input (LP)	Convection Blower
QFI35FB	140 lbs	3" x 3" Direct Vent	IntelliFire Plus	Yes	Yes	40,000 - 20,000	38,000 - 19,000	120 cfm
QFI30FB	105 lbs	3" x 3" Direct Vent	IntelliFire Plus	Yes	Yes	36,000 - 17,000	36,000 - 19,000	120 cfm

DIMENSIONS									
MODEL	FRONT WIDTH		BACK WIDTH		HEIGHT		DEPTH		VIEWING AREA
	UNIT	MIN. FIREBOX OPENING	UNIT	MIN. FIREBOX OPENING	UNIT	MIN. FIREBOX OPENING	UNIT	MIN. FIREBOX OPENING	
QFI35FB	33-7/8	35	24-15/16	25-1/2	24-3/8	24-7/8	16-5/8	18-1/4	31-3/8 x 19-7/8
QFI30FB	29-3/16	30-1/4	20-15/16	21-1/2	22-5/16	22-7/8	15-1/8	16-7/8	26-11/16 x 17-7/8

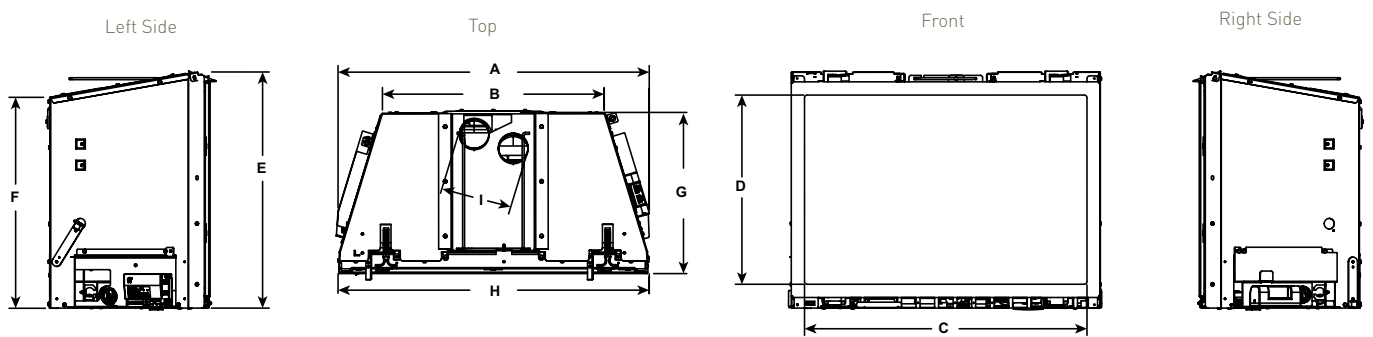

MODEL	A	B	C	D	E	F	G	H
QFI35FB	33-13/16	24-15/16	31-3/8	19-7/8	24-3/8	21-3/4	16-5/8	33-7/8
QFI30FB	29-3/8	20-15/16	26-11/16	17-7/8	22-5/16	19-15/16	15-1/8	29-3/16

GAS EFFICIENCIES

Steady State - Since most homeowners use their appliance for an extended time while they are in the room, Steady State measure how efficiently your appliance converts fuel to heat once it is warmed up and running in a "steady state".

AFUE - AFUE rating is more typically used with appliances, like your furnace, that continually cycle on and off to maintain a constant temperature.

EnerGuide (CSA P.4.1-02) - EnerGuide is a rating used in Canada to measure annual efficiency.

INSERT	U. S. EFFICIENCIES				CANADA ENERGUIDE	
	Steady State		AFUE		CSA P.4.1-02	
	NG	LP	NG	LP	NG	LP
QFI35FB	85.8%	86.0%	73.1%	73.8%	72.9%	73.8%
QFI30FB	85.8%	85.5%	70.1%	70.0%	70.7%	71.1%



www.quadrafire.com | 800-926-4356

[facebook.com/QuadraFire](https://www.facebook.com/QuadraFire)
twitter.com/QuadraFire
[youtube.com/QuadraFirePower](https://www.youtube.com/QuadraFirePower)

Available From:

Limited Lifetime Warranty**

The strongest in the industry, Quadra-Fire provides a limited lifetime warranty on the most important aspects: firebox and heat exchanger.

** For full warranty details go to www.quadrafire.com

IMPORTANT - READ BEFORE YOU INSTALL! Refer to the Owner/Installation Manual for complete clearance requirements and specifications. The images and descriptions in this brochure are provided to assist you in product selection only. Quadra-Fire is a registered trademark of Hearth & Home Technologies. Product specifications and pricing subject to change without notice.

Fireplace, stove and insert surfaces get extremely HOT and can cause severe burns if touched. Keep a safe distance away. To learn more visit www.quadrafire.com/fireplacesafety

